

Article number: 2082268M1615B

Description: E+G Mini indexing plunger
with/without rest position, GN 822.6-8-M16x1,5-B

Measures

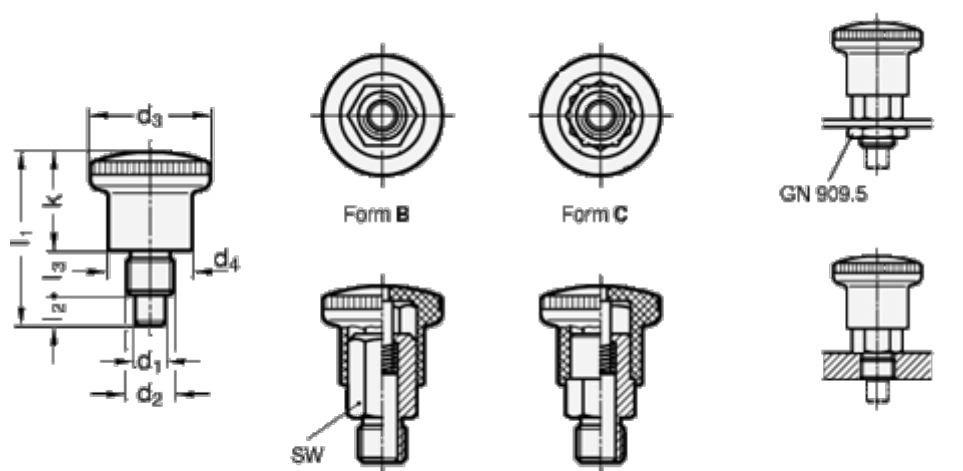

$d_1 = 8$

$d_2 = M16x1,5$

$d_3 = 33$

$d_4 = 23$

$k = 25.5$

$l_1 = 47.5$

$l_2 = 10$

$l_3 = 12$

Spring load initial $N = 11$